



Better Health. Better Future.

Health & Beauty

A complete line of beauty essentials
for nail, spa, and cosmetics.

Cotton, Esthetic, and Nail Wipes

Dukal Reflections™ Esthetic Wipes	4
Dukal Reflections™ Large Gauze Facial Wipes ...	4
Dukal Reflections™ Beauty Wipes	4
Dukal Reflections™ Cotton Filled Nail Wipes	4
Dukal Reflections™ Cotton Skin Care Pad	4
Gauze Wipes	5
Dukal Reflections™ Cotton Rounds	5
Dukal Reflections™ Gauze Facial Mask	5
Cotton Roll	6
Cotton Balls	6
Oval Eye Pads	6

Wax Applicators / Depilatory Products

Dukal Reflections™ Wax/Body Treatment Applicators	7
Dukal Reflections™ Glycolic Applicators	7
Tongue Depressors	7
Dukal Reflections™ Waxing Roll	8
Dukal Reflections™ Waxing Strips	8
Dukal Reflections™ Muslin Waxing Roll	8

Disposable Spa Undergarments

Dukal Reflections™ Thong	9
Dukal Reflections™ Bikini Panty	9
Dukal Reflections™ Backless Bra	9
Dukal Reflections™ Boxers	9
Dukal Reflections™ Stretch Headband	9

Disposable Linens / Treatment Solutions

Dukal Reflections™ Self-Sealing Sterilization Pouches	10
Dukal Reflections™ Table Paper	10
Tech-Med® Table Paper Dispenser	10
Body Toaster™ Spa Wrap	11
Dukal Reflections™ Makeup Remover Wipes	11
Dukal Reflections™ Disposable Pillowcase	11
Dukal Reflections™ Fitted Face Cradle Cover	11
Dukal Reflections™ Flannel Massage Fitted Face Rest Cover	11

Personal Protection

Level 1 and Level 3 Black Masks	12
Level 1 Flex Mask	12
Level 3 Fluidbloq Mask	12
Level 1 Surgical Masks	13
Level 2 Surgical Masks	13
Level 3 Surgical Masks	13
General Use Face Mask	14
Bouffant and Accordion Facial Caps	14
Shoe Covers	14

Barber

Dukal Barber The Ultimate Neck Strip	15
--------------------------------------------	----

Personal Care Products

Dukal Reflections™ Toe Nail Clippers	16
DawnMist® Nail Clippers	16
DawnMist® Manicure Sticks	16
DawnMist® Nail Brushes	16
Tech-Med® Hand Scrub Brush	16
DawnMist® Baby Combs	17
DawnMist® Hair Pic	17
DawnMist® Adult Brushes	17
DawnMist® Adult Combs	17
DawnMist® Razors	18
DawnMist® Shave Cream	19
DawnMist® Brushless Shave Cream	19
DawnMist® Shave Gel	19
DawnMist® After Shave Lotion	20
DawnMist® Stick Deodorant	20
DawnMist® Antiperspirant Deodorant	20

Skin Care and Bathing

DawnMist® Soap Box	21
Soap Box	21
DawnMist® Facial and Body Soap	21
DawnMist® Lotion Soap	21
DawnMist® Redi-Wash® Rinse Free Shampoo Cap	22
DawnMist® Shower Cap	22
DawnMist® Rinse Free Shampoo and Body Bath..	22
DawnMist® Rinse Free Foam Cleanser	22

Skin Care and Bathing (Continued)

DawnMist® Shampoo and Body Bath	23
DawnMist® Shampoo with Conditioner	23
DawnMist® Hair Conditioner.....	23
DawnMist® Shampoo, Shave Gel, and Body Wash	23
DawnMist® Corn Starch Baby Powder	24
DawnMist® Baby Oil	24
DawnMist® Tearless Baby Shampoo.....	24
DawnMist® Baby Bath	25
DawnMist® Baby Lotion	25
DawnMist® Hand and Body Lotion.....	25
DawnMist® Hydrating Aqua Cream.....	26

Disposable Washcloths

Dukal Reflections™ Disposable Washcloths	27
Dry Wash Cloths	27
Premium Wet Wipes.....	27
DawnMist® Pre-Moistened Adult Wash Cloths	28
DawnMist® Baby Wipes.....	28

Antiseptics and Cleansers

Alcohol Pads.....	29
BZK Towelettes	29
Cleansing Towelettes.....	29
Sting Relief Pads	30
Povidone Iodine	30

Traditional Wound Care

Caliber™ Adhesive Bandages	31
Cohesive Bandages	32

Oral Care

DawnMist® Toothbrushes	33
DawnMist® Toothbrush Holder and Cap	33

Sundry Items

Tech-Med® Glass Sundry Jars.....	34
Tech-Med® Lotion Pump	34
Tech-Med® Alcohol Bottles	34
Tech-Med® Nitrile Finger Cots	34
Tech-Med® Finger Cots.....	34

Sundry Items (Continued)

Tech-Med® Tape Measures.....	35
Tech-Med® Minute Minders.....	35
Tech-Med® Digital Timers.....	35
Tech-Med® Paper Tape Measures	35

Stainless Steelware

Tech-Med® Flat Trays.....	36
Tech-Med® Instrument Trays.....	36
Tech-Med® Tumblers	37
Tech-Med® Medicine Cups.....	37
Tech-Med® Bowls.....	37

Equipment

Tech-Med® Double Post Instrument Stand	38
Tech-Med® Double Post Instrument Stand with Large Tray.....	38
Tech-Med® Mobile Instrument Stand	39
Tech-Med® Single Post Instrument Stand.....	39
Tech-Med® Foot Stools.....	40
Tech-Med® Bariatric Foot Stools	40

Cotton, Esthetic and Nail Wipes



Dukal Reflections™ Esthetic Wipes

- 100% non-woven cotton
- Gentle and highly absorbent; ideal for removing product from skin
- Great for cleansing, exfoliating, and nail polish removal

Item #	Description	Packaging
Non-Sterile		
900300	2" x 2", 4-Ply	200/bg, 20 bg/cs
900305	3" x 3", 4-Ply	200/bg, 20 bg/cs
900310	4" x 4", 4-Ply	200/bg, 10 bg/cs

Dukal Reflections™ Beauty Wipes

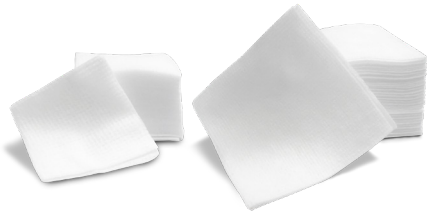

- Soft, absorbent rayon/poly blended, non-woven sponges
- Works great with the latest nail gels and polish removers
- Gentle on skin making them ideal for most esthetic procedures

Item #	Description	Packaging
Non-Sterile		
900340	2" x 2", 4-Ply, Blended	200/bg, 25 bg/cs
900345	4" x 4", 4-Ply, Blended	200/bg, 10 bg/cs



Dukal Reflections™ Large Gauze Facial Wipes



- Made of 100% cotton
- Opens to 12" x 16" single-ply sheet
- Can be used for facials and all skin care service

Item #	Description	Packaging
Non-Sterile		
900354	4" x 4", 12-Ply	200/bg, 10 bg/cs

Dukal Reflections™ Cotton Filled Nail Wipes



- 100% cotton filled gauze
- Ideal for polish removal and cleaning instruments & brushes

Item #	Description	Packaging
Non-Sterile		
900352	2" x 2", 8-Ply	200/bg, 25 bg/cs

Dukal Reflections™ Square Cotton Skin Care Pad

- Made with 100% cotton
- Ideal for use on the face to remove makeup, apply toner or other facial serums, and general cleaning

Item #	Description	Packaging
Non-Sterile		
900335	4" x 4"	100/bg, 24 bg/cs

Gauze Wipes



- 100% cotton
- Gentle and highly absorbent; ideal for removing product from skin
- Great for cleansing, exfoliating, and nail polish removal

Item #	Description	Packaging
Non-Sterile		
2085	2" x 2", 8-Ply	200/bg, 25 bg/cs
2128	2" x 2", 12-Ply	200/bg, 40 bg/cs
2128-100	2" x 2", 12-Ply	100/bg, 80 bg/cs
3084	3" x 3", 8-Ply	200/bg, 20 bg/cs
3124	3" x 3", 12-Ply	200/bg, 20 bg/cs
3124-100	3" x 3", 12-Ply	100/bg, 40 bg/cs
4084	4" x 4", 8-Ply	200/bg, 20 bg/cs

Dukal Reflections™ Cotton Rounds



- Embossed, quilt-like, 100% cotton rounds can be used wet or dry
- Ideal for make-up removal, for use during facials, and skin care procedures

Item #	Description	Packaging
Non-Sterile		
900372	2"	80/bg, 48 bg/cs
900373	2"	200/bg, 96 bg/cs
900374	3"	50/bg, 24 bg/cs
900375	3"	100/bg, 50 bg/cs

Dukal Reflections™ Gauze Face Mask



- 100% woven cotton gauze
- Can be used for paraffin hydrating masks, heated or cooling treatments, clay treatments, purifying or exfoliating treatments

Item #	Description	Packaging
Non-Sterile		
900350	Pre-Cut	50/pk, 10 pk/cs

Cotton, Esthetic and Nail Wipes

Cotton Roll



- 100% cotton
- Easy to unwind
- Short fibers make it easy to tear
- Packaged in a re-sealable drawstring polybag for your convenience

Item #	Description	Packaging
CR1-12	1lb Cotton Roll	1/bg, 12 bg/cs

Cotton Balls



- 100% cotton
- Soft and uniform in size
- Available in 2 sizes

Item #	Description	Packaging
Non-Sterile		
801	Medium	2000/bg, 2 bg/cs
802	Large	1000/bg, 2 bg/cs

Oval Eye Pads



- Absorbent cotton filled pad with a soft, gentle non-woven cover that offers protection to this delicate area
- Features an easy place tab on back to ensure clean placement
- Sealed edges provide minimal linting
- Individually wrapped and packaged in a dispenser box for your convenience

Item #	Description	Packaging
Sterile		
841	1-5/8" x 2-5/8"	1/pk, 50 pk/bx, 12 bx/cs

Dukal Reflections™ Wax/Body Treatment Applicators

- Can be used for applying wax, make-up and lotions, or mixing solutions
- 5 sizes available to accommodate a wide range of treatments and uses
- Bulk products are banded and shrink wrapped

Item #	Description	Packaging
Non-Sterile		
900410	6" x 3/4", Tongue Depressor, Large	100/pk, 25 pk/cs
900412	4 1/2" x 3/8", Popscile, Small	100/pk, 25 pk/cs
900414	5 1/2" x 1/4", Sturdy	100/pk, 25 pk/cs
900416	3 1/2" x 1/4", Extra Small	100/pk, 25 pk/cs
900418	5 1/2" x 1/4", Slim, Bendable	100/pk, 25 pk/cs
Non-Sterile- Bulk		
900429	5 1/2" x 1/4", Slim, Bendable	100/bundle, 100 bundles/cs
900420	6" x 3/4", Tongue Depressor, Large	50/bundle, 100 bundles/cs
900422	3/4" x 6", Tongue Depressor, Large	500/bx, 10 bx/cs



Dukal Reflections™ Glycolic Applicators



- Plastic handles with a non-absorbent poly/rayon tip make these applicators ideal for applying any product
- Dual tipped with perforated center to separate into two 4" single-headed applicators

Item #	Description	Packaging
Non-Sterile		
900400	Dual Tip, 8"	100/bx, 10 bx/cs

Tongue Depressors



- Clean and smooth hard wood blades
- Can be used for applying wax, make-up and lotions, or mixing solutions

Item #	Description	Packaging
Non-Sterile		
9001	Tongue Depressor, Junior, 5.5"	500/bx, 10 bx/cs
9002	Tongue Depressor, Senior, 6"	500/bx, 10 bx/cs
Sterile		
9004	Tongue Depressor, Senior, 6"	1/pk, 100 pk/bx, 10 bx/cs

Dukal Reflections™ Waxing Roll

- Made from non-woven, high-quality material and leaves no residue
- Material does not stretch or tear, ensuring a precise and clean waxing service
- Can be used with all depilatory systems
- Can be cut to any size



Item #	Description	Packaging
Non-Sterile		
900711	3" x 55 yds, roll	12 rl/cs
900713	3-1/2" x 100 yds, roll	10 rl/cs

Dukal Reflections™ Waxing Strips

- Made from non-woven, high-quality material and leaves no residue
- Material does not stretch or tear, ensuring a precise and clean waxing service
- Can be used with all depilatory systems
- Pre-cut strips are ideal for waxing legs and bikini area



Item #	Description	Packaging
Non-Sterile		
900714	3" x 9" strips	100/pk, 24 pk/cs

Dukal Reflections™ Natural Muslin Depilatory Waxing Roll

- An ideal choice for home or spa setting
- Can be used with all soft waxes
- Contours to skin and body for precise wax removal
- Provides maximum absorption with superior cotton quality
- Easily cut into any size for complete face and body hair removal
- Will not stretch, tear, or leave residue on skin during use
- A top choice tool for waxing at home



Item #	Description	Packaging
Non-Sterile		
900717	3"5 x 100 yds	1/rl, 10 rl/cs

Disposable Spa Undergarments

Dukal Reflections™ Spa Undergarments

- Provides comfort with just the right amount of coverage
- Made of soft spun bonded polypropylene material
- Available in a variety of sizes and styles to accommodate multiple treatments
- Each garment is individually wrapped for hygienic purposes
- Disposable



Item #	Description	Packaging
Non-Sterile		
900500-1	Thong Panty, White	1/bg, 100 bg/bx, 10 bx/cs
900502-1	Thong Panty, Black	1/bg, 100 bg/bx, 10 bx/cs
900504-1	Bikini Panty, White	1/bg, 100 bg/bx, 10 bx/cs
900506-1	Bikini Panty, Black	1/bg, 100 bg/bx, 10 bx/cs
900510-1	Backless Bra, Black, Sm/Med	1/bg, 100 bg/bx, 6 bx/cs
900512-1	Backless Bra, Black, Lg/XL	1/bg, 100 bg/bx, 6 bx/cs
900530	Boxers, Black, Sm/Med	1/pk, 50 pk/cs
900532	Boxers, Black, Lg/XL	1/pk, 50 pk/cs

Dukal Reflections™ Stretch Headband

- Hook and loop closure for a secure hold and flexible sizing
- Soft, disposable headbands keep hair comfortably off the face during spa treatments



Item #	Description	Packaging
Non-Sterile		
900552	White, Disposable	48/bg, 10 bg/cs
900554	White, Disposable, BULK	200/bg, 4 bg/cs



Disposable Linens / Treatment Solutions

Dukal Reflections™ Self-Sealing Sterilization Pouches

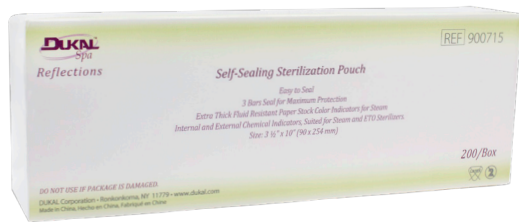

- Ideal for sterilizing spa instruments such as nail clippers and cuticle trimmers
- Made with self-seal adhesive strips and triple-sealed seams to keep out contaminants and maintain the sealed pouch within
- Easy to seal
- Contains color changing indicators for steam and ETO sterilization
- Not for use by healthcare providers to sterilize medical devices

Item #	Description	Packaging
900715	3 1/2" x 10"	200/bx, 10 bx/cs

Dukal Reflections™ Table Paper



- Provide a clean, protected work surface
- Features a high quality smooth paper finish that provides extraordinary strength

Item #	Description	Packaging
900112	Smooth, White, 21" x 225'	12 rl/cs

Dukal Reflections™ Make-Up Remover Wipes



- Non-woven, spunlace towelettes
- Gently and easily clean skin to remove all traces of makeup, dirt, oil and waterproof mascara

Item #	Description	Packaging
900702	8" x 6"	45/pk, 12 pk/cs

Tech-Med® Table Paper Dispenser



- Accommodates 18" or 21" paper rolls
- Includes: 2 stainless steel brackets and removable metal rods, instructions, and 4 screws
- Easily attached to the examination table

Item #	Description	Packaging
4060	With Cutter	1/ea

⚠️ WARNING: This product can expose you to chemicals including Di(2-ethylhexyl)phthalate (DEHP), which are known to the State of California to cause cancer and birth defects or other reproductive harm. For more information go to www.P65Warnings.ca.gov.

Body Toaster™ Spa Wrap



- Mylar foil wrap that captures and traps body heat to intensify any full body treatment
- Compact packaging allows for convenient storage

Item #	Description	Packaging
900105	52" x 84"	1/pk, 250/cs

Dukal Reflections™ Pillowcase



- Soft, linen-like non-woven fabric that provides comfort and convenience while ensuring strength and durability
- Our high-quality disposable pillowcases helps reduce the risk of cross-contamination between customers.

Item #	Description	Packaging
900533	White, 21" x 27.75"	100/cs

Dukal Reflections™ Fitted Face Cradle Cover



- Protects the headrest of most spa tables
- 13" Circumference (unstretched)
- Vacuum packed for maximum storage efficiency

Item #	Description	Packaging
900540	White, Disposable	100/bg, 12 bg/cs

Dukal Reflections™ Flannel Massage Fitted Face Rest Cover



- Made of 100% premium cotton flannel
- Fits most spa table face rests
- Durable and long-lasting for commercial use

Item #	Description	Packaging
900545	Lavender	25/bg, 8 bg/cs
900546	Natural	25/bg, 8 bg/cs
900547	Sage	25/bg, 8 bg/cs
900548	White	25/bg, 8 bg/cs



ASTM F2100
LEVEL 1 2 3

ASTM RATED LEVEL 1 AND LEVEL 3

Black Ear-Loop Face Masks

Level 1

- Meets and/or exceeds ASTM Level 1 Standards
- 4-Layer, 3-fold
- Superior breathability
- Ultra soft inner layer



ASTM F2100
LEVEL 1 2 3

Level 3

- Meets and/or exceeds ASTM Level 3 Standards
- 4-Layer, 4-fold
- Superior breathability
- Ultra soft inner layer

Item#	ASTM Rated	Packaging
ULM-6180	Level 1	50/BX, 20 BX/CS
ULM-6380	Level 3	50/BX, 20 BX/CS

Flex Mask Level 1

- Meets and/or exceeds ASTM Level 1 Standards
- 3-Layer, 4-fold
- Superior breathability
- Ultra soft inner layer
- Pop-out flex center strip

Packaging: 50/BX, 20 BX/CS

WITH FLEX TECHNOLOGY

a unique **pop-out center strip** to enhance breathability and reduce mask movement when speaking



				
Blue	White	Lavender	Green	Pink
ULM-6181	ULM-6182	ULM-6184	ULM-6185	ULM-6189

FluidBloq Mask Level 3

- Meets and/or exceeds ASTM Level 3 Standards
- 4-Layer, 4-fold
- Superior breathability
- Ultra soft inner layer
- FluidBloq mesh layer provides superior fluid resistance

Packaging: 50/BX, 20 BX/CS



		
Blue	White	Pink
ULM-6381	ULM-6382	ULM-6389



Level 1 Surgical Masks

- 3-ply pleated lightweight, breathable material
- BFE of $\geq 99\%$
- Meet or exceed ASTM Level 1 standards
- Available in earloop or tie on with flexible nosepiece
- Not made with natural rubber latex

Item #	Description	Packaging
Non-Sterile		
1540	Surgical Mask, with Ties, Blue	50/bx, 6 bx/cs
1541	Ear Loop, Blue	50/bx, 6 bx/cs
1550	Anti-Fog, w/Tie, Blue	50/bx, 6 bx/cs



Level 2 Surgical Masks

- BFE of $\geq 99\%$
- Meets ASTM Level 2 standards
- Flexible nosepiece
- Not made with natural rubber latex

Item #	Description	Packaging
Non-Sterile		
1580	Ear loop, Blue	50/bx, 12 bx/cs



Level 3 Surgical Masks

- BFE of $\geq 98\%$
- Meets ASTM Level 3 standards
- Flexible nosepiece
- Not made with natural rubber latex

Item #	Description	Packaging
Non-Sterile		
1590	Ear loop, Blue	50/bx, 12 bx/cs



General Use Face Mask

- 3-ply pleated with earloop
- Lightweight, provides comfortable face protection
- Not for medical use
- Replacement for 900610

Item #	Description	Packaging
Non-Sterile		
1525	Blue, Earloop	50/bg, 40 bgs/cs



Bouffant and Accordion Facial Caps

- Can be used to protect the client's hair during facial treatments or keep esthetician's hair securely in place
- The accordion style cap is compactly designed to minimize packaging, save space, and then expand to full size for use

Item #	Description	Packaging
Non-Sterile		
321B	Bouffant Cap, 21", Blue	100/bx, 5 bx/cs
324B	Bouffant Cap, 24", Blue	100/bx, 5 bx/cs
321-10	Bouffant Cap, 21", Blue	100 /bg, 10 bgs/cs
324-10	Bouffant Cap, 24", Blue	100 /bg, 10 bgs/cs
900550	DUKAL Reflections™ Facial Cap, 21", Accordion	1000/cs



Shoe Covers

- Made of spunbonded polypropylene
- Non-skid treads on bottom for traction

Item #	Description	Packaging
Non-Sterile		
350-10	Non-Skid	100 /bg, 10 bgs/cs

Dukal Barber The Ultimate Neck Strip



- Soft, highly absorbent tissue is easy to use and is available in convenient bundles of 60 pre-cut strips
- Stretches to fit easily and comfortably around customer's neck
- For use during facial, make-up, waxing, and hair services

Item #	Description	Packaging
900712	Neck Strips	60/bndl, 12 bndl/bx, 4 bx/cs



Personal Care Products

Dukal Reflections™ Toe Nail Clippers



- Carbon Steel

Item #	Description	Packaging
Non-Sterile		
900430	Curved Edge	12/bx, 20 bx/cs
900431	Straight Edge	12/bx, 20 bx/cs

DawnMist® Nail Clippers



- DawnMist® products are made of high strength, corrosion resistant carbon steel, for durability and performance

Item #	Description	Packaging
Fingernail Clippers		
FNC3268	2 1/4", with file	6/bx, 48 bx/cs
FNC3275	2 1/4", without file	6/bx, 48 bx/cs
Toenail Clippers		
TNC3282	3 1/4", with file	6/bx, 24 bx/cs
TNC3299	3 1/4", without file	6/bx, 24 bx/cs

DawnMist® Nail Care Accessories

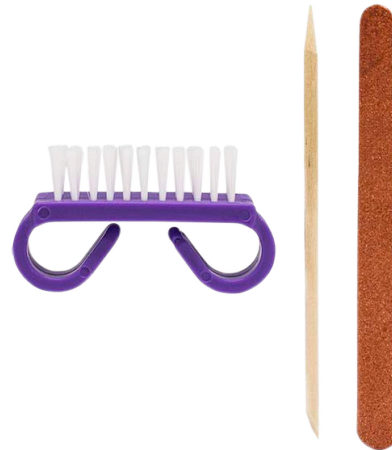

- Manicure Sticks are made of bamboo and have one pointed end and one tapered end
- Emery Boards have two coarseness levels
- Nail Brushes have three rows of soft, nylon bristles and purple handle

Item #	Description	Packaging
Manicure Sticks		
CS45B	4 1/2"	144/bx, 50 bx/cs
Emery Boards		
EB01B	4 1/2", two-sided	144/bx, 24 bx/cs
Nail Brushes		
NB3381	2 3/4"	50/bx

Tech-Med® Hand Scrub Brush



- Long lasting nylon bristles provide thorough scrub without scratching

Item #	Description	Packaging
Non-Sterile		
4416	4 1/4" x 1 5/8"	12/bx

DawnMist® Baby Combs



- Soft nylon and plastic bristles are gentle on scalp, rounded tips

Item #	Description	Packaging
PC01	Ivory, Comb, Two-sided	12/bg, 72 bg/cs

DawnMist® Adult Brushes

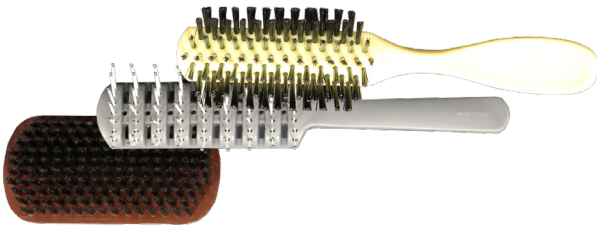

- Multiple sizes to accommodate all hair types

Item #	Description	Packaging
HB01	7 1/4", Long, Ivory, Nylon Tuft Bristle	1/bg, 12 bg/bx, 24 bx/cs
HB02	8" Long, Gray, Plastic Bristles Rounded	1/bg, 12 bg/bx, 24 bx/cs
HB03	Block Style, Oval, Nylon Bristles, No Handle	12/bx, 24 bx/cs

DawnMist® Hair Pic



- Rounded fines to reduce irritation caused by scratching

Item #	Description	Packaging
567	5 1/4", Mini, Black, Wide	576/cs

DawnMist® Adult Combs



- Rounded fines to reduce irritation caused by scratching

Item #	Description	Packaging
C5	5" Long, Black - BULK	2160/cs
DC5	5" Long, Black	12/bg, 180 bg/cs
GC5	5" Long, Black	144/bg, 15 bg/cs
C7	7" Long, Black - BULK	1440/cs
DC7	7" Long, Black	12/bg, 120 bg/cs
GC7	7" Long, Black	144/bg, 10 bg/cs
C7I	7" Long, Ivory - BULK	1440/cs
C8	8" Long, Black, Heavy Duty Dresser - BULK	1008/cs
2655	6 1/2", Black, Handle	720/cs
2950	8 5/8", Black, Handle	432/cs

DawnMist® Triple Play™ Facial Razor

- Feature Microedge™ blades, a lubricated strip, and a pivot head

Item #	Description	Packaging
DR3886	Teal Handle, Triple Blade	10/bx, 50 bx/cs



Premium

DawnMist® Grip-N-Glide™ Razor

- Feature Microedge™ blades and a lubricated strip

Item #	Description	Packaging
DR3879	Blue Handle, Twin Blade	100/bx, 20 bx/cs



DawnMist® Standard Disposable Razors

- Feature Microedge™ blades, and clear plastic guards, unisex

Item #	Description	Packaging
DR03	Orange Handle, Single Blade	100/bx, 20 bx/cs
DR05	Blue Handle, Twin Blade	100/bx, 20 bx/cs
DR06	Dark Blue Handle, Twin Blade	100/bx, 20 bx/cs



DawnMist® Shave Cream



- Thick, rich foam has gentle formula and pleasant fragrance leaving skin feeling fresh and smooth
- Alcohol Free

Item #	Description	Packaging
	Aerosol Can	
SC15	1.5 oz.	144/cs
SC110-12	11 oz.	12/cs

DawnMist® Shave Gel



- Extra-mild, pH balanced formula protects and conditions skin
- Contains peppermint oil to leave skin feeling refreshed
- Alcohol Free

Item #	Description	Packaging
	Clear Plastic Tube with Twist Cap	
SGW4807	0.85 oz.	144/bx, 4 bx/cs
SGW4814	3 oz.	144/cs

DawnMist® Brushless Shave Cream



- Contains conditioners and lubricants to soften and protect skin
- Alcohol Free

Item #	Description	Packaging
	Single-Use Packet	
PBS35	0.125 oz.	200/bx, 10 bx/cs
PBS70	0.25 oz.	100/bx, 10 bx/cs
	Plastic Tube with Twist Cap	
BS06	0.6 oz.	144/bx, 5 bx/cs
BS85	0.85 oz.	144/bx, 4 bx/cs
BS30	3 oz.	144/cs



DawnMist® After Shave Lotion



- Light-weight, non-oily formulation soothes irritated skin, and helps to reduce dryness

Item #	Description	Packaging
ASL04	Bottle with Twist Cap 4 oz.	60/cs

DawnMist® Antiperspirant Deodorant



- Fights wetness and odor

Item #	Description	Packaging
Single-Use Gel Packets		
PD25G	0.10 oz., Fresh Scent	200/bg, 5 bg/cs
Roll-On		
RD15	1.5 oz., Fresh Scent	96/cs
RD7990	1.5 oz., Fresh Scent, Clear Bottle	96/cs
RD20	2 oz., Unscented	96/cs
Pump Spray		
PSD20	2 oz., Fresh Scent	48/cs
PSD40	4 oz., Fresh Scent	48/cs

DawnMist® Stick Deodorant



- Clean fresh scent helps fight odor

Item #	Description	Packaging
SD05	0.5 oz.	144/bx, 4 bx/cs
SD175	1.6 oz.	144/cs

DawnMist® Soap Box



- Hinged lid helps keep soap dry and can hold up to a #5 bar

Item #	Description	Packaging
SB01C	Translucent Plastic	100/cs
SB01	Ivory Plastic	100/cs

Soap Box:



- Keeps soap dry
- 2 piece

Item #	Description	Packaging
	Individually Wrapped	
MILDTSUB1A12N	Clear	1/bg, 12 bg/bx, 12 bx/cs

DawnMist® Facial and Body Soap



- Gentle formula with mild fresh scent, French milled for a longer lasting product, does not contain animal fat or by-products

Item #	Description	Packaging
	Individually Wrapped	
SP05-500	# 1/2	500/cs
SP75-500	# 3/4	500/cs
SP10	# 1	500/cs
SP15-250	# 1 1/2	250/cs
SP30	# 3	100/cs
	Unwrapped	
SPU30	# 3, Bulk	100/cs

DawnMist® Lotion Soap



- Gentle formula effective for cleansing and moisturizing the skin
- Light jasmine scent that is enriched with conditioners to soothe frequently washed hands

Item #	Description	Packaging
	Bottle with Dispensing Cap	
BG02	2 oz.	144/cs
BG3329	4 oz.	96/cs
	Easy Pour with Pump	
BG128	1 Gallon	4/cs

Skin Care and Bathing

DawnMist® Redi-Wash® Rinse Free Shampoo Cap



- A convenient all-in-one hair cleansing system
- Cleanses and conditions hair without the need for a sink or water
- Soothing, sanitary, pH balanced

Item #	Description	Packaging
Non-Sterile		
SC3756	Rinse-Free Shampoo Cap	40 bg/cs

DawnMist® Rinse Free Shampoo and Body Bath



- Mild, pH balanced formula helps maintain skins moisture

Item #	Description	Packaging
	Bottle with Dispensing Cap	
NRB4463	2 oz.	144/cs
NRB4586	4 oz.	96/cs
NR08	8 oz.	12/bx, 4 bx/cs
NRB4593	16 oz.	12/cs

DawnMist® Shower Cap



- Keeps hair and scalp dry during shower

Item #	Description	Packaging
SC01	Clear	200 bg/bx, 10 bx/cs

DawnMist® Rinse Free Foam Cleanser



- Enriched with aloe vera and is pH balanced
- Fresh scent helps reduce odors
- CHG compatible formula
- Tear free, sulfate free, paraben free and hypoallergenic
- An all-in-one rinse free system that is designed for perineal, skin and hair cleansing
- Eliminates labor-intensive cleansing and the use of bacteria-prone basin baths
- Convenient rinse free foam helps reduce clean up time, and is easily removed with wipes or washcloth

Item #	Description	Packaging
	Bottle with dispensing cap	
RFFC04	4 oz.	24/cs
RFFC08	8 oz.	12/cs

DawnMist® Shampoo and Body Bath

- Full body cleansing in one simple step with a fresh apricot scent and a gentle, pH balanced formula

Item #	Description	Packaging
Bottle with Dispensing Cap		
MS02	2 oz.	144/cs
MS3367	4 oz.	96/cs
MS08	8 oz.	48/cs
MS16	16 oz.	12/cs
Easy Pour with Pump		
MS128	1 Gallon	4/cs
Single-Use Packet		
PS10	0.35 oz.	100/bg, 10 bg/cs



DawnMist® Shampoo with Conditioner

- Shampoo and condition in one easy step leaving hair soft and manageable with a refreshing herbal scent

Item #	Description	Packaging
Single-Use Packet		
PSC70	0.25 oz., Clear	100/bx, 5 bx/cs



DawnMist® Hair Conditioner

- Moisturizes hair and scalp
- Easy rinse formula
- Leaves hair soft and manageable
- Alcohol Free

Item #	Description	Packaging
Bottle with Dispensing Cap		
HC02	2 oz.	144/cs
HC3336	4 oz.	96/cs
HC08	8 oz.	48/cs



DawnMist® Shampoo, Shave Gel and Body Wash

- 3 steps all in one bottle, Gentle formula with refreshing peppermint scent

Item #	Description	Packaging
Clear Bottle with Dispensing Cap		
SSB02C	2 oz.	96/cs
SSB04C	4 oz.	60/cs



Skin Care and Bathing

DawnMist® Corn Starch Baby Powder



- Helps to absorb wetness
- Talc Free
- Premium powder contains soothing Aloe and Vitamin E

Item #	Description	Packaging
	Premium - Bottle with Dispensing Cap	
BP15	1.5 oz	96/cs
BP35C	3.5 oz.	48/cs
BPC14	14 oz.	24/cs

Standard - Bottle with Dispensing Cap

BP02	2 oz.	96/cs
BP35	4 oz.	48/cs
BP65	6.5 oz.	48/cs
BP14	14 oz.	24/cs

DawnMist® Baby Oil



- Made of pure mineral oil that helps to soothe and soften skin, great for both babies and adults

Item #	Description	Packaging
	Bottle with Dispensing Cap	
BA02	2 oz.	144/cs
BA3312	4 oz.	96/cs
BA08	8 oz.	48/cs
BA16	16 oz.	12/cs

DawnMist® Tearless Baby Shampoo



- pH balanced formula gentle on hair, scalp, and eyes; Leaves hair soft and manageable
- Light baby fresh scent is great for both babies and adults

Item #	Description	Packaging
	Bottle with Dispensing Cap	
TS4470	2 oz.	144/cs
TS4487	4 oz.	96/cs
TS4494	8 oz.	48/cs
TS4500	16 oz.	12/cs



DawnMist® Baby Bath

- Gentle pH balanced formula can be used from head to toe; Light baby fresh scent

Item #	Description	Packaging
Bottle with Dispensing Cap		
BB4517	2 oz.	144/cs
BB4524	4 oz.	96/cs
BB4548	16 oz.	12/cs



DawnMist® Baby Lotion

- Gentle formula ideal for delicate skin
- Helps to keep skin soft and smooth
- Light, fresh scent is great for both babies and adults

Item #	Description	Packaging
Bottle with Dispensing Cap		
BL4555	2 oz.	144/cs
BL4562	4 oz.	96/cs



DawnMist® Hand and Body Lotion

- Mild coconut fragrance
- Soothes and moisturizes skin
- Contains Aloe and Vitamin E
- Alcohol free

Item #	Description	Packaging
Bottle with Dispensing Cap		
HL02	2 oz.	144/cs
HL3343	4 oz.	96/cs
HL08	8 oz.	48/cs



Easy Pour with Pump		
HL128	1 Gallon	4/cs
Single-Use Packet		
PH10	0.35 oz.	100/bg, 10 bg/cs

DawnMist® Hydrating Aqua Cream

- Thick velvety texture that absorbs easily, while helping to maintain the natural moisture balance for skin throughout the day.
- A moisture balanced cream that hydrates while it softens, dry, irritated and sensitive skin.
- Hypoallergenic
- CHG compatible
- Paraben free
- Non-greasy
- Light coconut scent



Item #	Description	Packaging
	Tube with Dispensing Cap	
PHC02	2 oz.	24/cs
PHC04	4 oz.	12/cs

Dukal Reflections™ Washcloths

- Linen-Like, soft and comfortable to use while wiping clients's skin
- Strong enough to handle other tasks such as general cleansing
- Can be used wet or dry
- Gentle, disposable cloths that are perfect for individual client use
- Can also be utilized as a disposable nail mat



Item #	Description	Packaging
Non-Sterile		
900709	White, 12" x 13.5"	40/pk, 8 pk/cs

Dry Wash Cloths

- Soft airlaid material that is embossed for increased absorption and ideal for cleanups, bathing, and general use



Item #	Description	Packaging
Non-Sterile		
7710	10" x 13"	50/bg, 10 bg/cs

Premium Wet Wipes

- Durable to withstand the toughest of jobs
- Aloe and Lanolin with a mild fresh scent
- Alcohol free



Item #	Description	Packaging
Non-Sterile		
7720	9" x 13" Hard Tub, Scented	64/tub, 8 tubs/cs
7748	9" x 13", Soft Pack, Scented	48/pk, 12 pk/cs

Disposable Washcloths

DawnMist® Pre-Moistened Adult Wash Cloths

- Extremely soft yet tear resistant, alcohol free, and with Aloe and Lanolin with a mild fresh scent

Item #	Description	Packaging
Non-Sterile - 9" x 13"		
AW4739	Hard Tub, Scented	64/tub, 12 tubs/cs
AW4746	Soft Pack, Scented	64/pk, 12 pk/cs
AW4750	Soft Pack, Flip Top Lid, Scented	64/pk, 8 pk/cs
Non-Sterile - 8" x 12"		
AW3688	Hard Tub, Scented	50/tub, 12 tubs/cs
AW8140	Soft Pack, Scented	50/pk, 12 pk/cs
AW8150	Soft Pack, Flip Top Lid, Scented	50/pk, 12 pk/cs
Non Sterile - 8" x 10"		
AW8210*	Soft Pack, Flip Top Lid, Scented	100/pk, 6 pk/cs
AW8212*	Soft Pack, Flip Top Lid, Unscented	100/pk, 6 pk/cs

*Hypoallergenic and CHG Compatible



DawnMist® Baby Wipes

- Extremely soft yet durable spunlace material, Alcohol free, and with Aloe and Lanolin
- Pre-moistened with a gentle no rinse formula

Item #	Description	Packaging
Non-Sterile- Unscented		
BWU4296	7" x 8"	40/tub, 24 tubs/cs
BWU4340	7" x 8"	80/tub, 12 tubs/cs
BWU4024	Refill Pack	40/pk, 24 pks/cs



Alcohol Pads

- Saturated with 70% isopropyl alcohol
- Ideal for use as an antiseptic cleanser
- 2-ply, non-woven pads

Item #	Description	Packaging
Sterile		
853	Medium	1/pk, 200/bx, 20 bx/cs
861	Large	1/pk, 100/bx, 10 bx/cs
Non-Sterile		
852	Medium	1/pk, 200/bx, 20 bx/cs
852-1000	Medium, Bulk	1/pk, 1000/bx, 4 bx/cs



BZK Towelettes

- First Aid to help reduce the risk of infection in minor cuts, scrapes and burns
- 5" x 8"

Item #	Description	Packaging
Non-Sterile		
855	5" x 8"	1/pk, 100/bx, 20 bx/cs
855-1000	5" x 8", Bulk	1/pk, 1000/cs
855-1200	5" x 8", Bulk	3/strip, 1/pk, 1200/cs



Cleansing Towelettes

- For cleansing of face, hands, and body without soap and water
- 5" x 8"

Item #	Description	Packaging
Non-Sterile		
858	5" x 8"	1/pk, 100/bx, 20 bx/cs
858-1000	5" x 8, Bulk	3/strip, 1/pk, 1500/cs



Antiseptics and Cleansers

Sting Relief Pads

- Temporary relief of pain and itching associated with minor burns, scrapes, and insect bites
- 2-ply non-woven pad



Item #	Description	Packaging
Non-Sterile		
856	Medium	1/pk, 200/bx, 20 bx/cs
856-1000	Medium, Bulk	3/strip, 1/pk, 1500/bx, 2 bx/cs

Povidone Iodine

- Povidone-Iodine USP 10% solution
- Used for patient preoperative skin preparation
- Helps to reduce bacteria that potentially can cause skin infection
- Sterile, single-use, easy to use foil pouch

Item #	Description	Packaging
Sterile		
882-4000	PVP-I Prep Pads, Medium	4000/cs
883-500	PVP-I Prep Swabstick 3's, 4"	500/cs
884-1000	PVP-I Prep Swabstick 1's, 4"	1000/cs
885-500	PVP-I 3/4 oz Solution Pouch	500/cs
886-250	PVP-I 1 oz Solution Pouch	250/cs



Caliber™ Adhesive Bandages

- Durable plastic, sheer, or flexible fabric to meet all market needs
- Absorbent, non-adherent pad protects and cushions the wound without sticking
- Sterile and individually wrapped in easy to peel pouches

Item #	Description	Packaging
Sterile - Plastic		
7616	3/4" x 3"	100/bx, 24 bx/cs
7617	1" x 3"	100/bx, 24 bx/cs
7611	2" x 4", X-Large	100/bx, 24 bx/cs
7614	Spot, 7/8" Round	100/bx, 24 bx/cs
Sterile - Clear/Sheer		
7604	3/4" x 3"	100/bx, 24 bx/cs
7608	1" x 3"	100/bx, 24 bx/cs
7612	2" x 4", X-Large	100/bx, 24 bx/cs
7615	Spot, 7/8" Round	100/bx, 24 bx/cs
Sterile - Fabric		
7602	Knuckle	100/bx, 24 bx/cs
7605	3/4" x 3"	100/bx, 24 bx/cs
7609	1" x 3"	100/bx, 24 bx/cs
7613	2" x 4", X-Large	100/bx, 24 bx/cs
7618	Fingertip	100/bx, 24 bx/cs
Sterile - Butterfly Wound Closure Strips		
7600	3/8" x 1 13/16"	100/bx, 24 bx/cs

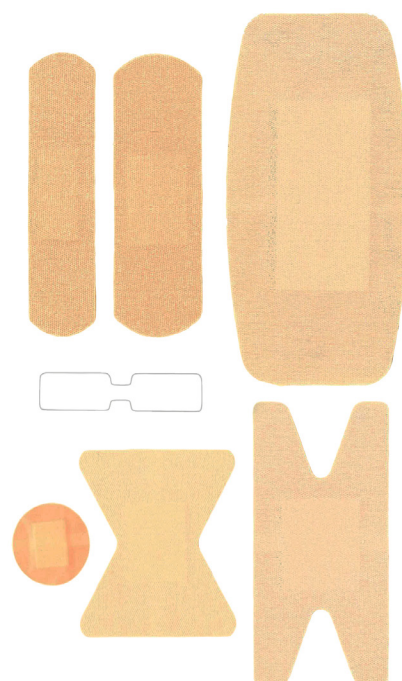

Cohesive Bandages

- Provides consistent support and maintains compression
- Can easily be torn by hand and is self adherent; no clips or fasteners are needed
- Lightweight, porous, and conforms well with movement
- LF series not made with natural rubber latex

Item #	Description	Packaging
Non-Sterile - Contains Latex		
8015DB	Dark Blue, 1" x 5 yds	30 rl/bx
8015W	White, 1" x 5 yds	30 rl/bx
8015T	Tan, 1" x 5 yds	30 rl/bx
8015AS	Assorted, 1" x 5 yds	30 rl/bx
8155DB	Dark Blue, 1.5" x 5 yds	48 rl/bx
8155W	White, 1.5" x 5 yds	48 rl/bx
8155T	Tan, 1.5" x 5 yds	48 rl/bx
8155AS	Assorted, 1.5" x 5 yds	48 rl/bx
8025DB	Dark Blue, 2" x 5 yds	36 rl/bx
8025T	Tan, 2" x 5 yds	36 rl/bx
8025AS	Assorted, 2" x 5 yds	36 rl/bx
8035DB	Dark Blue, 3" x 5 yds	24 rl/bx
8035T	Tan, 3" x 5 yds	24 rl/bx
8035AS	Assorted, 3" x 5 yds	24 rl/bx
8045T	Tan, 4" x 5 yds	18 rl/bx
8045AS	Assorted, 4" x 5 yds	18 rl/bx

Item #	Description	Packaging
Non-Sterile - Not made with Natural rubber Latex		
8016TLF	Tan, 1" x 5 yds	30 rl/bx
8016ASLF	Assorted, 1" x 5 yds	30 rl/bx
8156TLF	Tan, 1.5" x 5 yds	48 rl/bx
8156ASLF	Assorted, 1.5" x 5 yds	48 rl/bx
8026TLF	Tan, 2" x 5 yds	36 rl/bx
8026BKLF	Black, 2" x 5 yds	36 rl/bx
8026ASLF	Assorted, 2" x 5 yds	36 rl/bx
8036TLF	Tan, 3" x 5 yds	24 rl/bx
8036BKLF	Black, 3" x 5 yds	24 rl/bx
8036ASLF	Assorted, 3" x 5 yds	24 rl/bx
8046TLF	Tan, 4" x 5 yds	18 rl/bx
8046ASLF	Assorted, 4" x 5 yds	18 rl/bx
8046BLLF	Blue, 4" x 5 yds	18 rl/bx
8046PLLF	Purple, 4" x 5 yds	18 rl/bx



DawnMist® Toothbrushes

- Feature soft bristles with rounded polish tips and individually packaged

Item #	Description	Packaging
Individually Bagged – 27 Tuft		
TBJR	Child's, Blue Handle	144/bx, 10 bx/cs
Individually Bagged - 30 Tuft		
TB20	High Visibility, Short Orange Handle	144/bx, 10 bx/cs
TB20i	Short Ivory Handle	144/bx, 10 bx/cs
TB29	Yellow Handle	144/bx, 10 bx/cs
TB30	Ivory Handle, Clear Polypropylene Bristles	144/bx, 10 bx/cs
Individually Bagged – 39 Tuft		
TB40	Purple Handle	144/bx, 10 bx/cs
TB40i	Ivory Handle	144/bx, 10 bx/cs
Individually Bagged – 46 Tuft		
TB46	Green Handle	144/bx, 10 bx/cs
Individually Bagged – Blue Styrene Handle – 52 Tuft		
TB52	Two-Color Premium Nylon Bristles	144/bx, 10 bx/cs
Individually Bagged		
TB5118	Security Toothbrush, White Thumbprint Handle	144/bx, 10 bx/cs



DawnMist® Toothbrush Holder and Cap

- Holder fits a variety of toothbrushes. Top of holder and caps are vented to allow for brushes to dry

Item #	Description	Packaging
Plastic Tube		
TBH01	2-Piece, Ivory	100/cs
TBH01C	2-Piece, Translucent	100/cs
Cap - Fits: TB30, TB29, TB46, TB52, TB5118		
TBCAP	Ivory	144/bg, 10 bg/cs



Sundry Items

Tech-Med® Glass Sundry Jars



- Flint glass jars with stainless steel lids
- Unlabeled

Item #	Description	Packaging
Non-Sterile		
4014	3" x 3"	1/bx, 6 bx/cs
4013	4" x 4"	1/bx, 6 bx/cs
4017	7" x 3"	1/bx, 6 bx/cs
4008	8 ½" x 4"	1/bx, 6 bx/cs
4012	7" x 4 ¼"	1/bx, 6 bx/cs

Tech-Med® Lotion Pump



- Dispensing design produces a steady stream of liquid controlled by finger pressure
- Size: 4 3/4" x 2.12"

Item #	Description	Packaging
Non-Sterile		
4026	9 oz.	12/bx

Tech-Med® Alcohol Bottles



- Unique push down dispensing design prevents cross contamination by not allowing dispensed fluid to return to bottle
- Locking cap prevents fluid from leaking out
- Excellent for dispensing isopropyl alcohol and other cleaners and solvents
- Bottles opaque color allows for fluid level visibility

Item #	Description	Packaging
Non-Sterile		
4024	9 oz., Imprinted	12/bx
4025	9 oz., No Imprint	12/bx

Tech-Med® Nitrile Finger Cots



- Pre-rolled natural white, powder free
- Not made of natural rubber latex
- Minimum of .08mm thickness
- Anti-static

Item #	Description	Packaging
Non-Sterile		
4404S	Nitrile, Small	144/bx
4404M	Nitrile, Medium	144/bx
4404L	Nitrile, Large	144/bx
4404XL	Nitrile, X-Large	144/bx

Tech-Med® Finger Cots



- Pre-rolled natural white, powder free
- Provide user protection and to prevent contamination and infection

Item #	Description	Packaging
Non-Sterile		
4423S	Small	144/bx
4423M	Medium	144/bx
4423L	Large	144/bx
4423XL	X-Large	144/bx

Tech-Med® Tape Measures

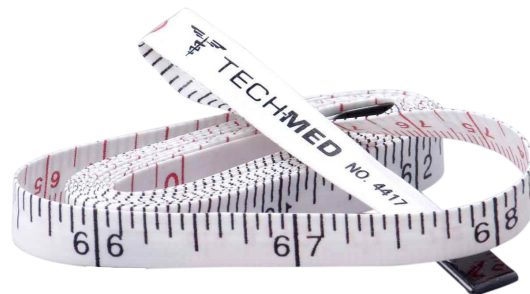

- Durable linen-like fiberglass tape
- Graduated English scale and metric on reverse side
- Retractable tape measures come in white plastic case with push button to retract tape measure

Item #	Description	Packaging
Non-Sterile		
4417	1/4" x 72"	10/pk
4422	Retractable, 1/4" x 120"	6/bx
4414	Retractable, 1/4" x 72"	6/bx



Tech-Med® Minute Minders

- 60 minute wind up timer
- White plastic housing with large black numbers
- Lays flat on desk or can be hung

Item #	Description	Packaging
Non-Sterile		
4450	3 3/4" x 3" x 2 1/4"	1/bx



Tech-Med® Digital Timers

- Counts down and up from the max time of 99 minutes.
- Includes a spring loaded clip and magnet
- 1 AAA Battery included

Item #	Description	Packaging
Non-Sterile		
4452	2-3/4" x 2-3/4" x 1/2"	1/bx

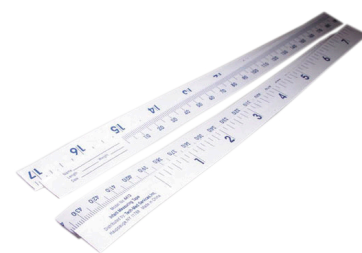

Tech-Med® Paper Tape Measures

- Graduated English scale and metric on reverse side

Item #	Description	Packaging
Non-Sterile		
4413	24"	1000/bx
4412	36"	1000/bx

Tech-Med® Flat Trays

- Made of high grade stainless steel (18/8, 304)
- Crafted without seams which helps prevent bacteria and allows for easy cleaning
- Autoclavable

Item #	Description	Packaging
Non-Sterile		
4261	13 5/8" x 9 3/4" x 5/8"	12/bx
4262	15 1/8" x 10 1/2" x 5/8"	12/bx
4263	17 1/8" x 11 5/8" x 5/8"	12/bx
4264	19 1/8" x 12 1/2" x 5/8"	1/ea
4266	Replacement Tray, Large, 16 3/4" x 21" x 1/2"	1/ea



Tech-Med® Instrument Trays

- Made of high grade stainless steel (18/8, 304)
- Crafted without seams which helps prevent bacteria and allows for easy cleaning
- Autoclavable

Item #	Description	Packaging
Non-Sterile		
4254	Strap handle 8 1/2" x 3" x 1 1/2"	6/bx
4255	Strap handle 8 7/8" x 5" x 2"	6/bx
4257	Strap handle 17" x 4" x 1"	6/bx
4256	Recess grip 12 1/8" x 7 5/8" x 2"	6/bx
4258	No cover 8 7/8" x 5" x 2"	6/bx
4259	No cover 12 1/8" x 7 5/8" x 2"	6/bx
4260	Strap handle 12" x 8" x 2"	1/ea
4265	Strap handle 12" x 3.2" x 2"	1/ea



Tech-Med® Tumblers



- Made of high grade stainless steel (18/8, 304)
- Crafted without seams which helps prevent bacteria and allows for easy cleaning
- Autoclavable

Item #	Description	Packaging
Non-Sterile		
4242	7 oz.	12/bx
4242-1	12 oz.	12/bx

Tech-Med® Medicine Cups



- Made of high grade stainless steel (18/8, 304)
- Crafted without seams which helps prevent bacteria and allows for easy cleaning
- Autoclavable

Item #	Description	Packaging
Non-Sterile		
4241	2 oz.	12/bx

Tech-Med® Bowls

- Made of high grade stainless steel (18/8, 304)
- Crafted without seams which helps prevent bacteria and allows for easy cleaning
- Autoclavable

Item #	Description	Packaging
Non-Sterile		
4247	7 qt	12/bx
4248	3/8 qt	24/bx
4249	1 qt	24/bx
4250	1 2/5 qt	30/bx
4251	1 7/8 qt	24/bx



Double Post Instrument Stand:

- Includes high grade stainless steel tray (18/8, 304)
- Base minimizes interference with other equipment
- Weight Capacity Standard: 15 lbs
- Depth at base: 19-1/4"
- Inside Base Area: 10-1/2" at widest end
5-1/2" at narrow end
- Replacement tray available

Item #	Description	Packaging
* 4368	Double Post	1/ea
4264	Replacement Tray, 12-1/2" x 19"	1/ea

* **⚠ WARNING:** This product can expose you to chemicals including chromium (hexavalent compounds), which are known to the State of California to cause cancer and birth defects or other reproductive harm. For more information go to www.P65Warnings.ca.gov.



Double Post Instrument Stand with Large Tray:

- Includes high grade stainless steel tray (18/8, 304) that is 25% larger than standard trays
- Base minimizes interference with other equipment
- Weight Capacity Standard: 50 lbs
- Depth at base: 24-1/3"
- Inside Base Area: 10-1/2" at widest end
6-1/4" at narrow end
- Replacement tray available

Item #	Description	Packaging
* 4366	Double Post	1/ea
4266	Replacement Tray, 16-3/4" x 21-1/2"	1/ea

* **⚠ WARNING:** This product can expose you to chemicals including chromium (hexavalent compounds), which are known to the State of California to cause cancer and birth defects or other reproductive harm. For more information go to www.P65Warnings.ca.gov.

Single Post Instrument Stand:

- Includes highest grade stainless steel tray (18/8,304) U-shaped base minimizes interference with other equipment
- Base Width: 20"
- Weight Capacity: 11 lbs
- Replacement tray available

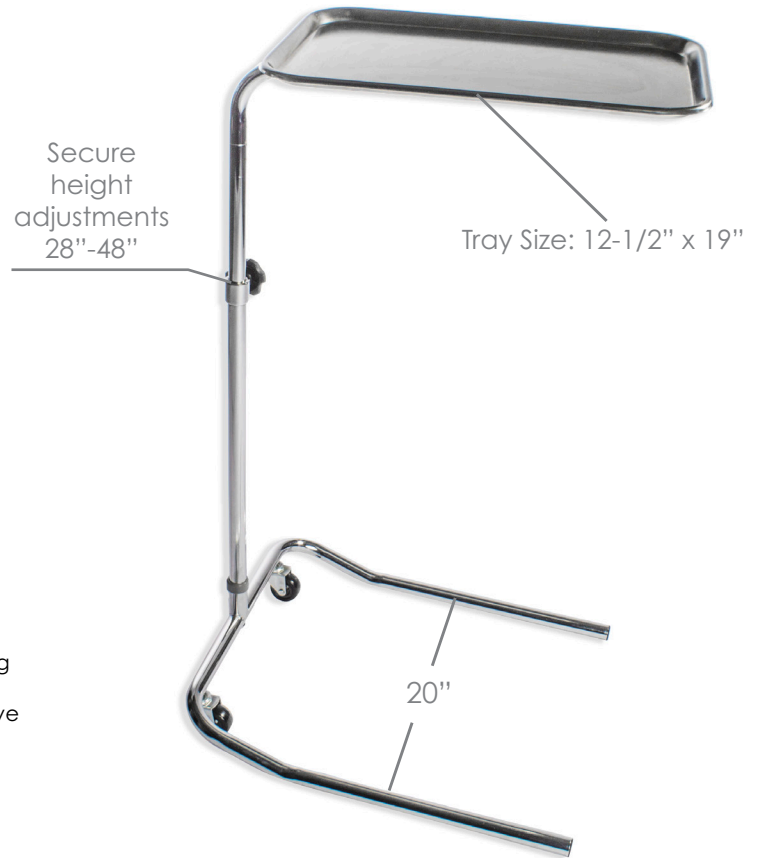

Item #	Description	Packaging
* 4352	Single Post	1/ea
4264	Replacement Tray, 12-1/2" x 19"	1/ea

* **⚠️ WARNING:** This product can expose you to chemicals including chromium (hexavalent compounds), which are known to the State of California to cause cancer and birth defects or other reproductive harm. For more information go to www.P65Warnings.ca.gov.



Mobile Instrument Stand:

- Includes highest grade stainless steel tray (18/8, 304)
- Mobile base features locking casters
- Weight Capacity Standard: 11 lbs
- Replacement tray available

Item #	Description	Packaging
* 4365	Single Post	1/ea
4264	Replacement Tray, 12-1/2" x 19"	1/ea

* **⚠️ WARNING:** This product can expose you to chemicals including chromium (hexavalent compounds), which are known to the State of California to cause cancer and birth defects or other reproductive harm. For more information go to www.P65Warnings.ca.gov.

Foot Stools:

- Available in a chrome-plated or black finish with 11" x 14" platform
- 450lb weight capacity
- Platform topped with 10" x 13" non-skid rubber mat
- Handrail height 34"
- Not made with natural rubber latex

Item #	Description	Packaging
4351	Chrome	1/ea
4349	Handrail, Chrome	1/ea
4349-2	Handrail, Chrome	2/cs

⚠ WARNING: This product can expose you to chemicals including chromium (hexavalent compounds), which are known to the State of California to cause cancer and birth defects or other reproductive harm. For more information go to www.P65Warnings.ca.gov.



Foot Stool:

- Welded steel base
- 400lb weight capacity
- 11" x 14" platform topped with 10" x 13" non skid rubber mat
- 9" high
- Not made with natural rubber latex

Item #	Description	Packaging
4351BLK	Black	1/ea

⚠ WARNING: This product can expose you to chemicals including carbon-black extracts, which are known to the State of California to cause cancer. For more information go to www.P65Warnings.ca.gov.



Bariatric Footstools:

- Chrome plated steel
- 700 lb weight capacity
- 11" x 14" platform topped with 10" x 13" non skid rubber mat
- Handrail height is 34"
- Not made with natural rubber latex

Item #	Description	Packaging
4350	Chrome	1/ea
4348	Handrail, Chrome	1/ea

⚠ WARNING: This product can expose you to chemicals including chromium (hexavalent compounds), which are known to the State of California to cause cancer and birth defects or other reproductive harm. For more information go to www.P65Warnings.ca.gov.





Dukal, LLC

2 Fleetwood Ct, Ronkonkoma, NY
11779

Phone: 1 631 656 3800

Toll Free: 1 800 243 0741

Email: customerservice@dukal.com

To Place Orders: orders@dukal.com

Find our full line of products at dukal.com